

# RESPA ADVISOR<sup>®</sup>+

PRESSURE + CO<sub>2</sub> MONITORING SYSTEM

## OPERATION MANUAL

[Sy-Klone.com/RAinfo](http://Sy-Klone.com/RAinfo)

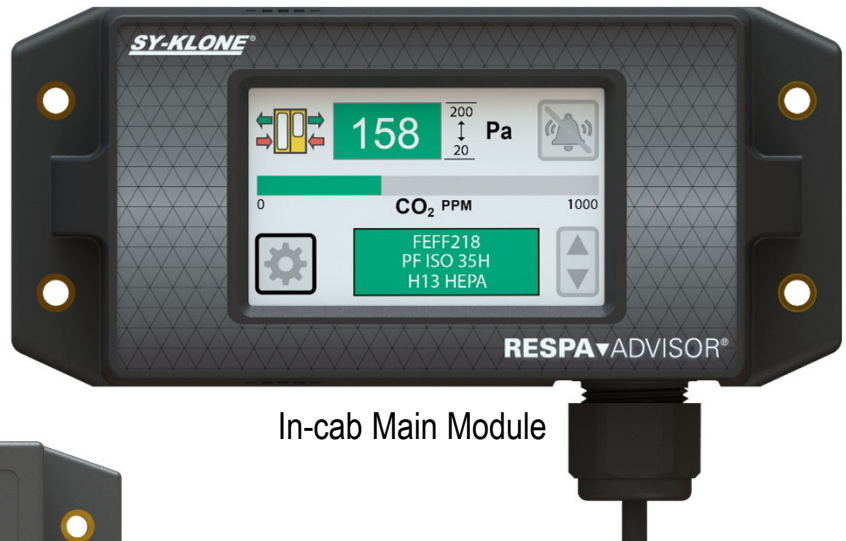

In-cab Main Module



External Ambient Pressure Sensor (APS)

**ISO 23875  
Compliant**

**SY-KLONE<sup>®</sup>**  
INTERNATIONAL

**Table of Contents**

**Technical Specifications ..... 3**

**Section 1: Getting Started**

Download RESPA Advisor+ Phone App ... 4  
 Access Online Resources ..... 4  
 Information Screen ..... 4

**Section 2: Introduction**

General Information ..... 5  
 Identification and Function of Parts ..... 5  
 Customizable Settings ..... 5  
 Pressure Monitor Default Settings ..... 5  
 Main Display Screen..... 5

**Section 3: Installation**

Mounting ..... 6  
 Wiring ..... 6

**Section 4: Initial Setup**

Hardware Setup ..... 6  
 Manual Filter Identification ..... 7  
 Manual Filter Setup ..... 7

**Section 5: User Options**

Setting Options ..... 8  
 Alarm Volume Setting ..... 8  
 Pressure Units of Measure Setting ..... 9  
 Pressure Alarm Setting ..... 9  
 Filter Life Setting ..... 9  
 Filter Identification Specifications ..... 10  
 Mute Length Setting ..... 11  
 CO<sub>2</sub> Alarm Threshold Setting ..... 11  
 Pin Code Setting ..... 11

**Section 6: User Operation**

Filter Identification ..... 12  
 Filter Life Screen ..... 12  
 Alarm Status ..... 12  
 Pressure Warning and Alarm ..... 13  
 CO<sub>2</sub> Warning and Alarm ..... 13  
 Filter Life Warning and Alarm . ..... 13  
 Muting the Alarm ..... 14  
 Replacing the Filter ..... 14  
 Bluetooth Settings ..... 14  
 Recalibrating the Monitor ..... 15  
 Data Logging Interval ..... 15  
 Data Logging Download ..... 15

## Technical Specifications

**Voltage:** 12-24 VDC (Undervoltage protection @ 10 VDC; Overvoltage protection @ 30 VDC)

**Current Consumption:**

- Main Module: Less than 30 mA
- Ambient Pressure Sensor: Less than 0.6 mA

**Inside/Outside Operating Temperature Rating:**

- Main Module: -10°C to 60°C (Inside cab)
- Ambient Pressure Sensor: -40°C to 80°C (Outside cab)

**Storage Temperature Rating:** -55°C to 125°C

**Operating Pressure Range:** 0 to 400 Pascal (Pa) (0 to 1.61 Inches-H<sub>2</sub>O)

**Operating CO<sub>2</sub> Range:** 0 to 5000 ppm

**Display Resolution:** 1 Pa (0.01 Inches-H<sub>2</sub>O)

**Weight:**

- Main Module: 426.0 g (15.0 oz)
- Ambient Pressure Sensor: 368.5 g (13.1 oz)

**Connector:** Deutsch part number DT04-2P-E005, qty 1; W2P secondary lock, qty 1; 0460-202-16141 contact pins, qty 2

**Dimensions:**

- Main Module: 164.8 x 75.3 x 43.6 mm (6.49 x 2.96 x 1.72 inches)
- Ambient Pressure Sensor: 134.3 x 81.1 x 44.1 mm (5.29 x 3.19 x 1.74 inches)

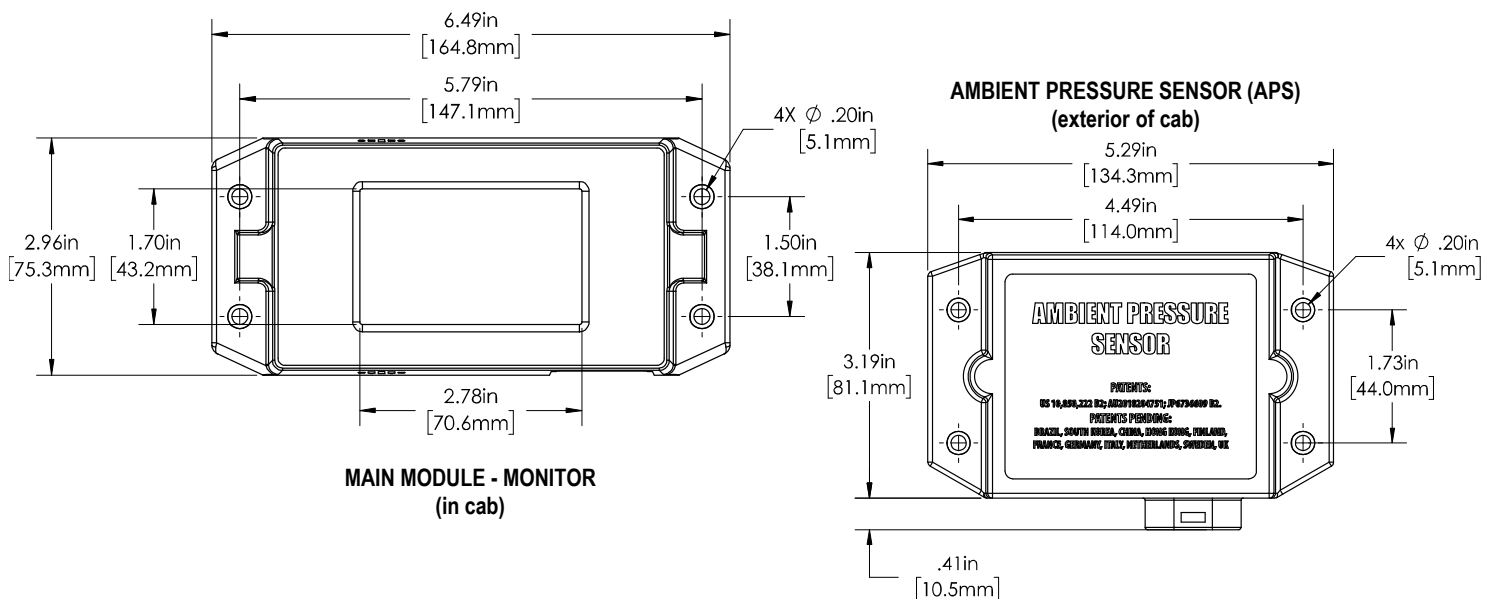

## Section 1: Getting Started

Thank you for your purchase of the RESPA Advisor+ Pressure and CO<sub>2</sub> monitor. You have now taken the first step to establishing better visibility to operator enclosure conditions on your job site.

Before installing the monitor, we encourage you to read through the full operation manual, including mounting and wiring instructions, and download the RESPA Advisor+ smart phone app.

Additional information and support is available online or through your authorized Sy-Klone reseller.

### Touchscreen Tip

If you have difficulty using the touchscreen with your fingertips, try using a stylus (not included). A ballpoint pen with the tip retracted works well, just be sure not to write on the screen with ink. Do not use anything sharp that can scratch the screen.

## Download the RESPA Advisor+ Smart Phone App

The RESPA Advisor+ provides insights into the operator cab environment with data logging at an interval you specify. Data logs can be downloaded via Bluetooth to the RESPA Advisor+ smart phone app and then shared to your computer, tablet, or other devices for further data analysis. To get started and access data logging, visit [Sy-Klone.com/RAinfo](http://Sy-Klone.com/RAinfo). To learn more about Data Logging, see page 14.



## Access Online Support Resources

Visit [Sy-Klone.com/RAinfo](http://Sy-Klone.com/RAinfo) to:

- Sign up for RESPA Advisor+ email updates.
- Access download links for the RESPA Advisor+ smart phone app for Apple iPhone and Android devices.
- Access digital version(s) of RESPA Advisor+ Operator Manual.

## Information Screen

During setup or once the system has been installed, accessing support is only a click away. Look for the Info button icon to access the support URL, scan the QR code, or visit [Sy-Klone.com/RAinfo](http://Sy-Klone.com/RAinfo) directly.

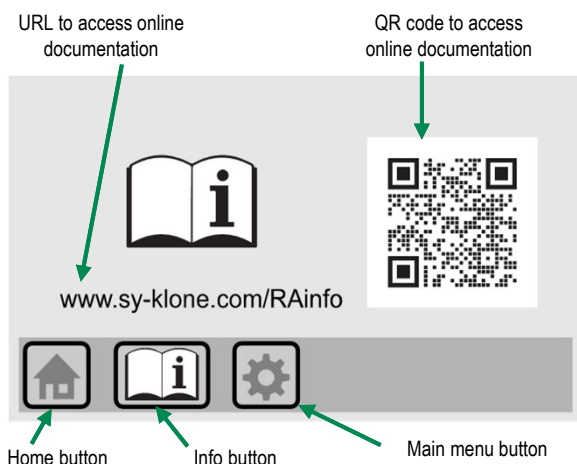

### NOTE: Multiple Unit Installations

The Monitor and Ambient Pressure Sensor in this box have been pre-paired.

If you are installing RESPA Advisor+ systems on multiple machines, keep the paired units together.

You can identify pairs by the matching numbers on the back of the units.

## Section 2: Introduction

The RESPA Advisor+ monitor provides the pressure difference between the outside, ambient pressure and the internal pressure of an enclosure, the CO<sub>2</sub> PPM (parts per million) level within the enclosure, and real-time indication of filter usage. This document gives instruction on installing and using the RESPA Advisor+ in an enclosed cab.

### General Information

- The main module should be installed within the operator's line of sight.
- The cab must be sealed and able to maintain pressure; check that all seals and gaskets are intact and add extra sealant where necessary.
- This unit works with 12/24 VDC systems. The system should be connected so it is powered when the key is turned on.
- The system utilizes a pressure-sensitive, LCD touch screen. Do not use anything sharp on the touch screen, as it may cause screen damage.
- When mounting the ambient pressure sensor (APS), mount sensor to exterior of cab, in a non-pressurized protected area, such as the exterior rear wall, where it will not be impacted by dirt, exposed to wind or direct airflow during machine movement, or exposed to excessive moisture.
- To assist in mounting the APS, an optional APS mounting/wiring kit that attaches to an existing RESPA® mount, which includes mounting adapter, bolts, and a wiring Y-harness to connect to the RESPA power source is available through your authorized Sy-Klone reseller.

### Customizable Settings

- Display pressure readings in Pascal or Inches of H<sub>2</sub>O
- Low-pressure alarm threshold with adjustable time to alarm
- High-pressure alarm threshold with adjustable time to alarm
- Primary CO<sub>2</sub> PPM alarm threshold
- Secondary CO<sub>2</sub> PPM alarm interval
- Adjustable alarm volume

### Monitor Default Settings

- **Sound:** On
- **Volume:** 75% of maximum volume level
- **Primary Alarm Mute:** Infinite
- **Secondary Alarm Mute:** 5 minutes
- **Pressure Units:** Pascal
- **Low Alarm Threshold:** 20 Pascal at 3 seconds
- **High Alarm Threshold:** 200 Pascal at 6 seconds
- **CO<sub>2</sub> Alarm Thresholds:** Primary 1000 PPM, Secondary 2500 PPM

### Identification and Function of Parts

The cab alarm sounds when cab pressure drops below the low-pressure threshold for three seconds or increases above the high-pressure threshold for six seconds, or when CO<sub>2</sub> levels exceed thresholds (alarms are user-adjustable). Alarm state resets when the cab conditions return to the acceptable range or when the power is cycled off/on.

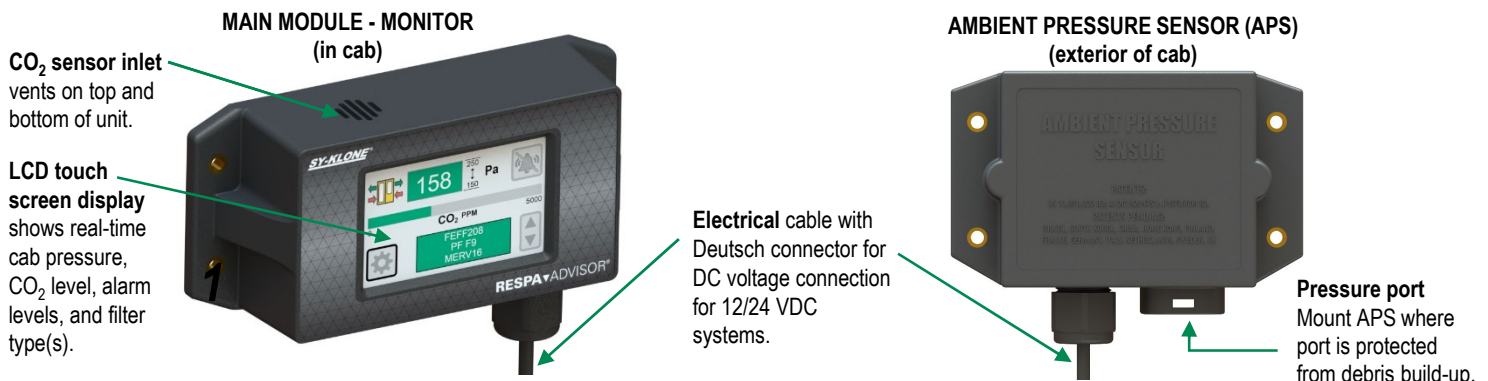

### Main Display Screen

The touch screen display shows, in real time, the cab pressure, CO<sub>2</sub> level, user-adjustable alarm levels, and the current filter(s) installed.

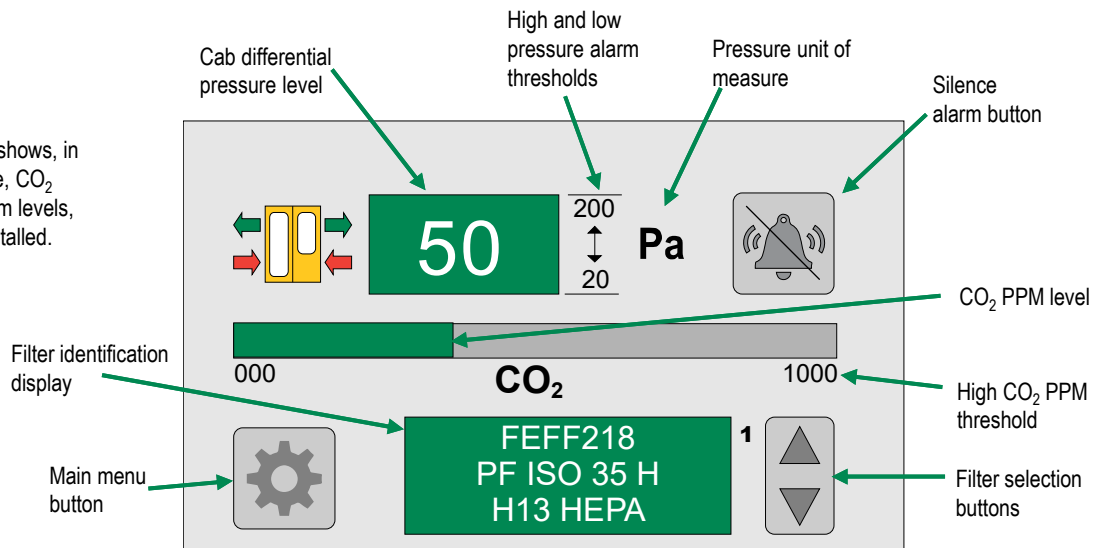

## Section 3: Installation

### Mounting

Review **General Information** on page 5 before starting installation.

The **monitor** can be mounted at any location inside the operator cab that is visible to the operator.

When deciding on the location, also take into consideration:

- It is necessary to touch the screen to make changes.
- The power wire must be routed to the machine's electrical system.

The monitor enclosure is designed with mounting tabs. Use the mounting tabs to secure the unit with installer-provided hardware.

The **APS** should be mounted outside the cab, positioned to prevent the pressure port from collecting debris. An optional mounting kit is available, described in General Info section on page 5.

#### NOTES:

- Use of lock washers is suggested. Additionally, double-sided tape can be used for main module installation.
- If needed, Sy-Klone offers a wiring harness kit (RCF2915) that includes 20-feet of wire with Deutsch connector, and heat-shrink, zip-ties, and clamps to secure cable.

### Wiring (both units)

The monitor power leads can be connected to any convenient DC voltage connection point meeting these criteria:

- The supply voltage must be between 10 VDC and 28 VDC.\*\*
- The voltage source is to be switched on/off with the vehicle power. If the vehicle has a key, make sure the connection point is "ON" with the key turned to the "on" position and "OFF" with the key in the "off" position.
- The power lead is to be fused appropriately. A 5A max fuse is recommended. If an appropriate fused connection point is not available, an inline fuse can be purchased.\*\*
- The power terminal is a Deutsch 2-pin connector.
- The RED lead is to be connected to (+, pin 1) positive battery voltage and the BLACK lead is to be connected to (-, pin 2) negative battery or vehicle ground.\*\*
- The electrical cable can be cut and shortened if desired.
- Secure the wire to the cab in a manner so as to protect the wire.
- The wire can be routed behind the cab panels as desired.

\*\*Failure to follow these instructions can result in non-function or permanent damage to the monitor.



## Section 4: Initial Setup

If the system installation is correct, the RESPA Advisor+ system will start when the key is turned on. If it does not, check wiring. A startup screen with the RESPA Advisor+ logo will appear and fade to the Main Display screen. The Ambient Pressure Sensor (APS) will connect automatically. You will know it is connected if the Pressure Display background is red, amber, or green. If it is not one of these colors, check Bluetooth settings to manually connect. (See *Bluetooth Settings*, page 14). If the APS is connected but color is not red, amber, or green, recalibrate (see page 15).

### Hardware Setup

The system will be set to default values for pressure and CO<sub>2</sub> alarm thresholds and can be used with no further configuration, but in order to take advantage of filter life tracking, you will need to go through the Main Menu to select and assign the RESPA filter(s) you are using. You may also adjust settings to synchronize filter life with your preventative maintenance cycles or debris conditions.

To enter the **Filter Selection Menu**:

1. Press the **Main Menu button** on the main display. 
2. The **PIN Code Screen** will be displayed. **Initial PIN code is 56538**. Press the **Reset button** to reset the display or press the **Home button** (on any screen) to return to the main display.
  - a. Enter PIN code. (**56538**)  
**TIP:** If you enter number incorrectly, press the **Reset button** to clear entry.
  - b. Press the **Confirm button** to enter the **Main Menu Screen**.
  - c. Press the **Filter Selection Menu button** to enter the Filter Selection screen. 

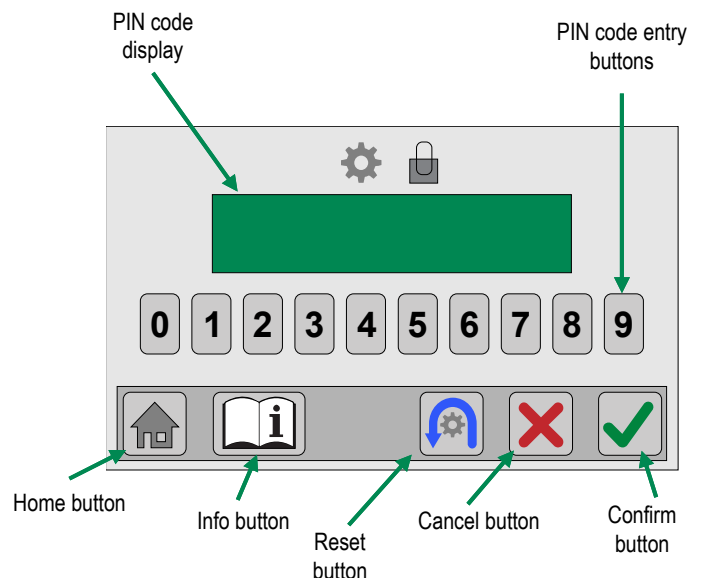

## Manual Filter Identification

### Manual Filter Information

There are six assignable filter locations (2-4, 6-8) that can house any of the listed Sy-Klone filters. (See page 10)

**Location 1 and 5 are reserved for future features.**

Either fresh or recirculation filters can be installed into these locations. Tracking the life of each filter can be done through the **Filter Tracking screen**. (See page 12)

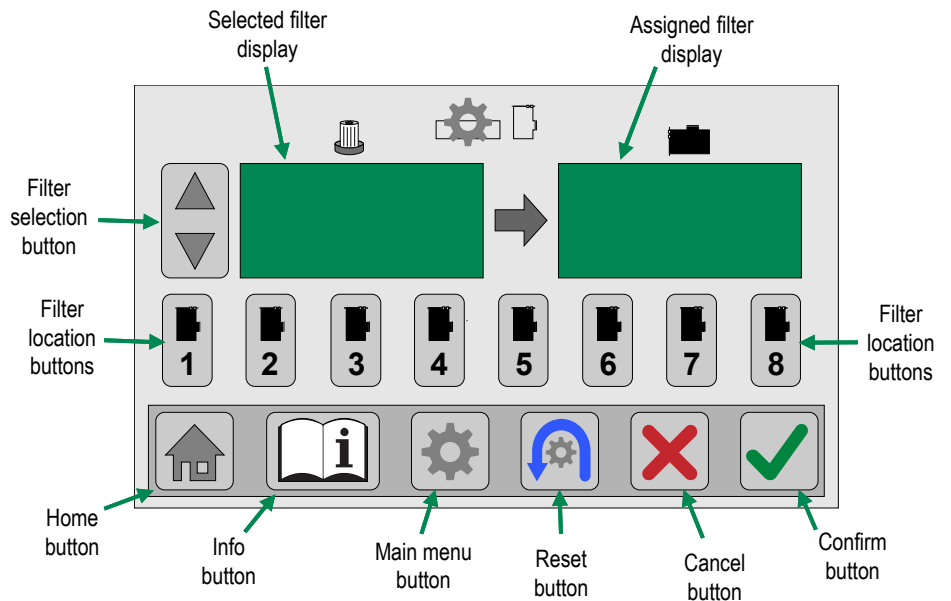

### Manual Filter Setup

**NOTE: Location 1 and 5 are reserved for future features.**

1. Use the **Up/Down Filter Selection button** to select the filter to be installed.
2. Hold the **Filter Location button (2-4 or 6-8)** to manually install the selected filter into the install filter display.
3. The installed filter will then populate in the **Installed Filter display** and the filter location will turn black to indicate a filter has been installed.
4. Press the **Confirm button** when all selections are correct and return to the main menu.

To exit without saving changes, press the **Main Menu button** or **Cancel button** to return to the Main Menu screen, or press the **Home button** to return to the main display.



Step 1

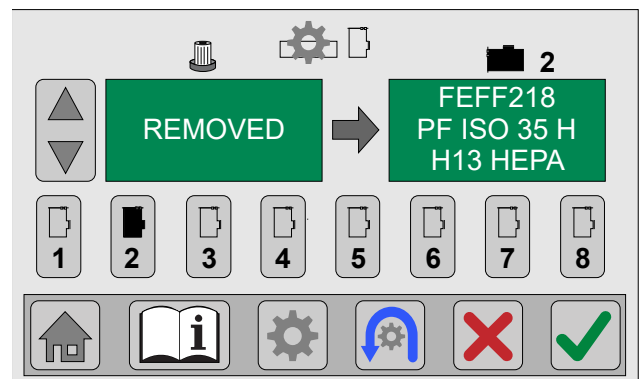

Step 2 & 3



## Section 5: User Options

### Setting Options

User-specific options can be changed in the **Main Menu screen**. To enter the user options, the PIN code must be entered. The default setting is 56538. (See *PIN Code Setting, page 11*)

To enter the **Main Menu screen**:

1. Press the **Main Menu button** on the main display.
2. Enter PIN code. **(Default: 56538)**  
If you enter code incorrectly, press **Reset button** to clear entry.
3. Press the **Confirm button** on the PIN Code screen to enter the Main Menu screen.

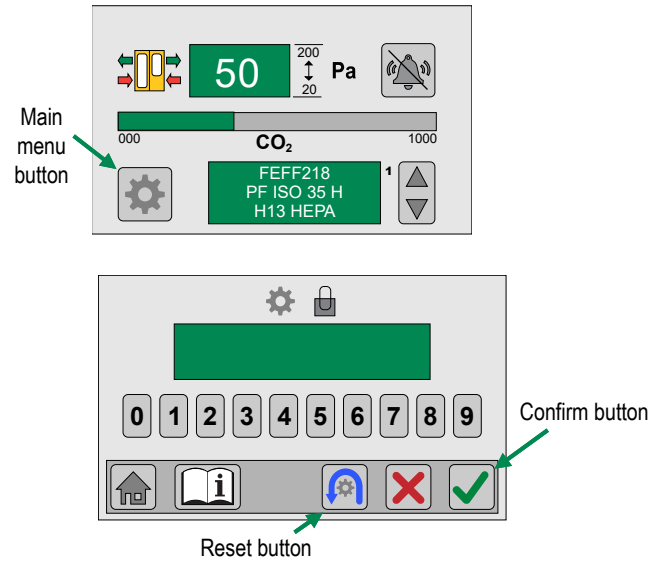

### Main Menu Screen

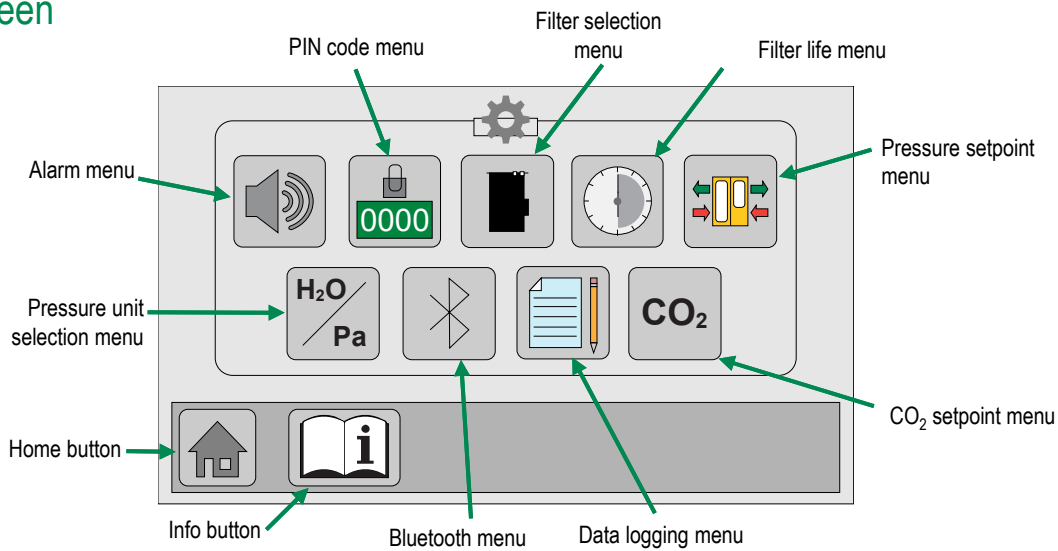

### Alarm Volume Setting

1. Use the **Up/Down Volume button** to adjust the alarm volume or press the **Reset button** to return the volume to the default (75% of maximum volume level).
2. Press the **Confirm button** to confirm any changes and return to the main menu screen.

To exit without saving changes, press the **Main Menu button** or **Cancel button** to return to the Main Menu screen, or press the **Home button** to return to the main display.

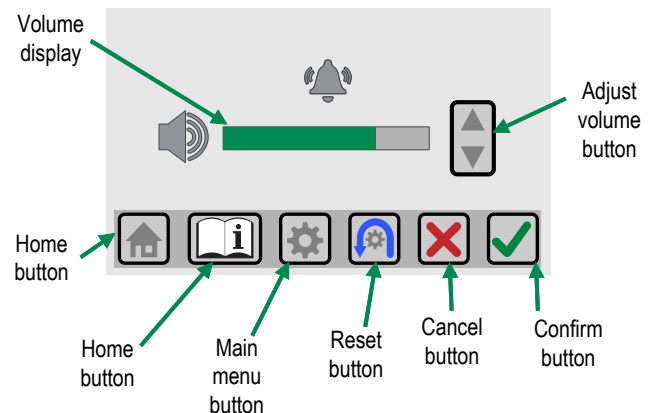



## Pressure Units of Measure Setting

Press either the **Pascal button** or **Inches of H<sub>2</sub>O button** to select the unit of measure for the alarm thresholds and real-time pressure display. **Note:** Selected unit will highlight in green. After selecting units, you will be returned to the Main Menu screen.

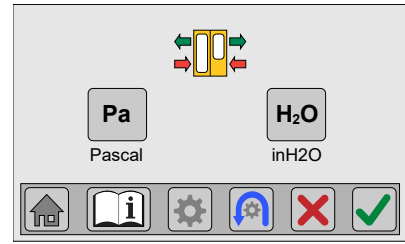

## Pressure Alarm Setting

1. Use the **Up/Down Alarm Threshold buttons** to adjust the low and high alarm levels or press the **Reset button** to return the pressure setting to the original settings (Low alarm – 20 Pa @ 3 sec, High alarm – 200 Pa @ 6 sec).
2. Use the **Up/Down Alarm Time buttons** to adjust the low and high time to alarm values (seconds).
3. Press the **Confirm button** to save changes and return to the main menu.

To exit without saving changes, press the **Main Menu button** or **Cancel button** to return to the Main Menu screen, or press the **Home button** to return to the main display.

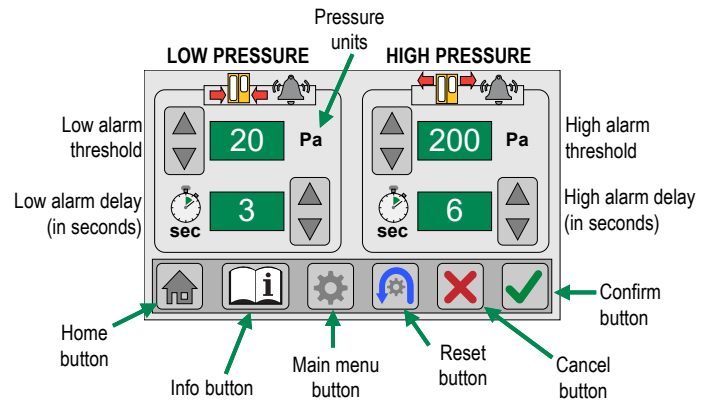

## Filter Life Setting

By default, the filter life is set to a pre-determined number of hours based on filter type (see next page), but can be altered to suit the conditions on your job site or to fit your preventative maintenance cycle by following the steps below.

1. Use the **Up/Down Filter Selection buttons** to select the installed filter you would like to adjust.
2. Use the **Up/Down Adjust Hours buttons** to adjust the filter life (hours). The maximum allowable time is determined by filter type. (See *Filter Identification Specifications*, next page)
3. If you wish to restore default value, press the **Reset button** to return the filter life hours to maximum allowed.
4. Press the **Confirm button** to save changes and return to the main menu.

To exit without saving changes, press the **Main Menu button** or **Cancel button** to return to the Main Menu screen, or press the **Home button** to return to the main display.

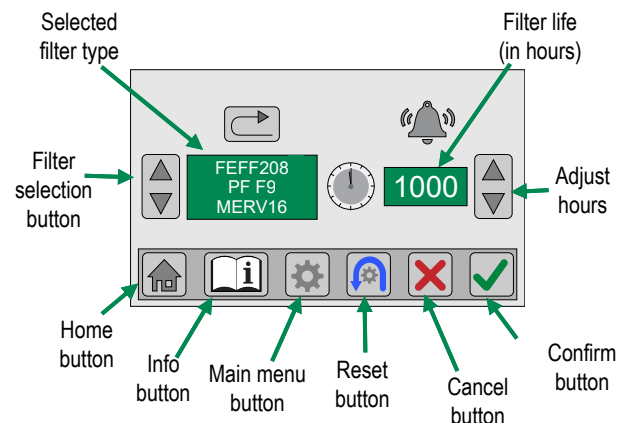

**NOTES:** Filter Life can only be adjusted once. If you wish to adjust again, the filter must be removed and selected again. (See *Manual Filter Setup Section*, page 7) Use the **Filter Life Menu screen** to reset the hours used after manual filter replacement. (See *Replacing the Filter*, page 14)

**Filter Identification Specifications**

The RESPA Advisor+ includes manual filter tracking for better insight on when to change your fresh or recirculated air filter. Below are the default settings for Sy-Klone RadialSHIELD® particulate, gas, and odor filters. To accommodate future filter releases, a CUSTOM filter option is included. For additional information on modifying default hours or setting a filter life for the CUSTOM filter selection, see page 9.

<b>Sy-Klone RESPA® Fresh and Recirculated Filters</b>						
<b>Part Number</b>	<b>Description</b>	<b>Display Information</b>			<b>Maximum Filter Life Setting (Hours)</b>	
		<b>Filter Type</b>	<b>Filter Length</b>	<b>Part Number</b>		
<b>FEFF108</b>	Standard Length, F9/MERV 16, Fresh Air, Ported Filter	PF F9/MERV 16	STD	FEFF108	750	
<b>FEFF109</b>	Extended Length, F9/MERV 16, Fresh Air, Ported Filter	PF F9/MERV 16	EXTD	FEFF109	1000	
<b>FEFF110</b>	Standard Length, H13/HEPA, Recirc Air, Closed Filter	PF H13/HEPA	STD	FEFF110	500	
<b>FEFF111</b>	Standard Length, F9/MERV 16, Recirc Air, Closed Filter	PF F9/MERV 16	STD	FEFF111	750	
<b>FEFF112</b>	Extended Length, F9/MERV 16, Recirc Air, Closed Filter	PF F9/MERV 16	EXTD	FEFF112	1000	
<b>FEFF113</b>	Extended Length, PF H13/HEPA, Recirc Air, Closed Filter	PF H13/HEPA	EXTD	FEFF113	750	
<b>FEFF118</b>	Standard Length, H13/HEPA, Fresh Air, Ported Filter	PF H13/HEPA	STD	FEFF118	500	
<b>FEFF119</b>	Extended Length, PF H13/HEPA, Fresh Air, Ported Filter	PF H13/HEPA	EXTD	FEFF119	750	
<b>FEFF120</b>	Standard Length, F9/MERV 16, Recirc Air, Louvered Filter	PF F9/MERV 16	STD	FEFF120	750	
<b>FEFF122</b>	Standard Length, H13/HEPA, Recirc Air, Louvered Filter	PF H13/HEPA	STD	FEFF122	500	
<b>FEFF208</b>	Standard Length, F9/MERV 16, Fresh Air, Ported Filter	PF F9/MERV 16	STD	FEFF208	750	
<b>FEFF209</b>	Extended Length, F9/MERV 16, Fresh Air, Ported Filter	PF F9/MERV 16	EXTD	FEFF209	1000	
<b>FEFF210</b>	Standard Length, H13/HEPA, Recirc Air, Closed Filter	PF H13/HEPA	STD	FEFF210	500	
<b>FEFF211</b>	Standard Length, F9/MERV 16, Recirc Air, Closed Filter	PF F9/MERV 16	STD	FEFF211	750	
<b>FEFF212</b>	Extended Length, F9/MERV 16, Recirc Air, Closed Filter	PF F9/MERV 16	EXTD	FEFF212	1000	
<b>FEFF213</b>	Extended Length, PF H13/HEPA, Recirc Air, Closed Filter	PF H13/HEPA	EXTD	FEFF213	750	
<b>FEFF218</b>	Standard Length, H13/HEPA, Fresh Air, Ported Filter	PF H13/HEPA	STD	FEFF218	500	
<b>FEFF219</b>	Extended Length, PF H13/HEPA, Fresh Air, Ported Filter	PF H13/HEPA	EXTD	FEFF219	750	
<b>FEFF220</b>	Standard Length, F9/MERV 16, Recirc Air, Louvered Filter	PF F9/MERV 16	STD	FEFF220	750	
<b>FEFF222</b>	Standard Length, H13/HEPA, Recirc Air, Louvered Filter	PF H13/HEPA	STD	FEFF222	500	
<b>FEFF130</b>	Extended Length, ABEK1 P3 HEPA, Fresh Air, Ported Filter	ABEK1 P3 HEPA	EXTD	FEFF130	250	
<b>FEFF131</b>	Standard Length, Odor HEPA, Fresh Air, Ported Filter	ODOR HEPA	STD	FEFF131	500	
<b>FEFF132</b>	Extended Length, Odor HEPA, Fresh Air, Ported Filter	ODOR HEPA	EXTD	FEFF132	750	
<b>Custom</b>	Custom	Custom			1000	

## CO<sub>2</sub> Alarm Threshold Setting

1. Use the **Up/Down Primary Alarm Threshold buttons** to adjust the CO<sub>2</sub> PPM alarm level for the primary alarm (Sy-Klone recommends setting the primary CO<sub>2</sub> alarm at the ambient CO<sub>2</sub> level + 400 PPM).
2. The secondary CO<sub>2</sub> alarm is not adjustable (Occupational Exposure Limit has been determined to be 2500 PPM). The interval at which the secondary CO<sub>2</sub> alarm can be silenced can be adjusted between 0 - 10 minutes using the **Up/Down Secondary Alarm Interval buttons**.
3. Press the **Reset button** to return the primary PPM alarm level to 1000 PPM and secondary alarm interval to 10 minutes.
4. Press the **Confirm button** to confirm any changes and return to the Main Menu screen.

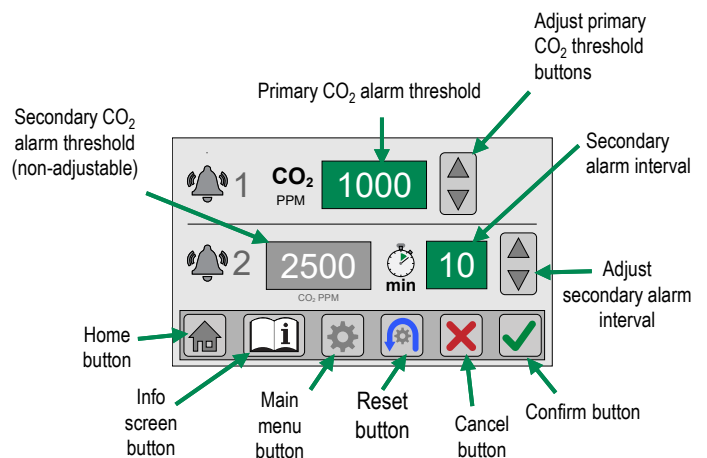

To exit without saving changes, press the **Main Menu button** or **Cancel button** to return to the Main Menu screen, or press the **Home button** to return to the main display.

## PIN Code Setting

To enter the Main Menu screen, the **PIN code must be entered**. (see *Hardware Setup, page 6*) The default PIN code is 56538. The existing PIN code of 5-digits can be altered through the PIN Code Menu.

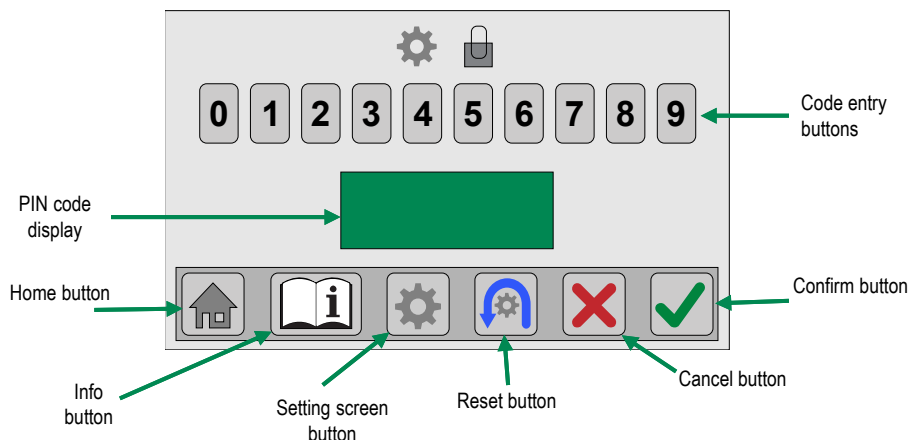

### To create a new PIN code:

**NOTE:** Only 5-digit PIN codes can be created and saved.

1. Enter the current PIN code to access the Main Menu.
2. Press the **PIN Code Menu button**. Then enter a new 5-digit PIN code.
3. Press the **Confirm button**. The PIN code will be saved as the new PIN code.

### To reset the current PIN code:

1. From the main display screen, press the **Main Menu button**.
2. Enter **99999999** (nine 9's) in the settings PIN Code screen.
3. Press the **Confirm button** to enter the Main Menu and create a new 5-digit PIN code in the PIN Code Menu.

**Section 6: User Operation**

**Filter Identification**

The Filter Identification display will show the filter information for the filter installed. Use the **Up/Down Filter Selection buttons** to view the filter information for any other filters installed.

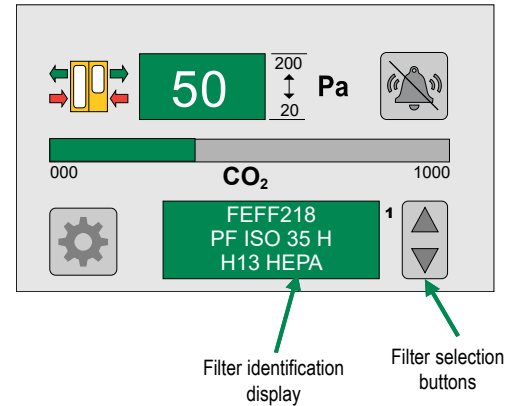

**Filter Life Tracking Screen**

- Press **Filter Identification display** on the Home screen to enter Filter Life screen. The maximum filter life hours are determined by the filter type. (See **Filter Identification Specifications**, page 10)
- The filter life bar will diminish from right to left.
- All installed filters can be viewed by using the **Up/Down Filter Selection buttons**.
- Press the **Home button** to return to the main display.

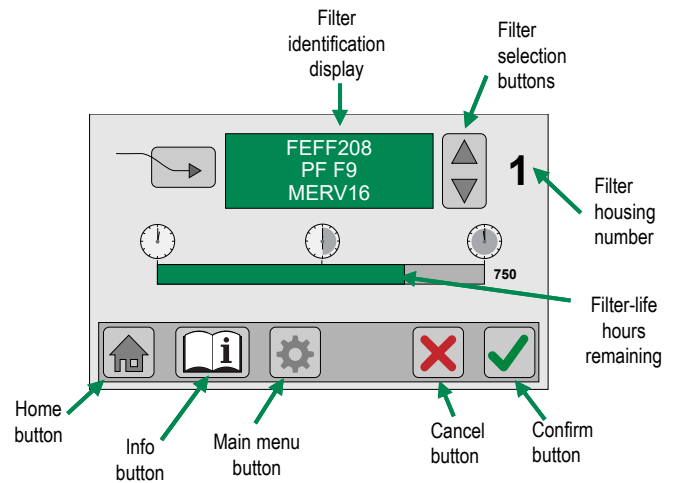

**Alarm Status**

The RESPA Advisor+ System will change display colors to visually alert the user for warnings as well as alarm situations. The audible alarm will sound under alarm situations if active.



## Pressure Warning and Alarm

- When the pressure reduces to 10% (of the range) above the set low-pressure alarm threshold, the cab pressure level display color will change to amber.
- When the pressure level reaches the set low-pressure alarm threshold, the cab pressure level display will change color to red and the alarm will sound.
- If the pressure increases to 10% (of the range) below the set high-pressure alarm threshold, the cab pressure level display color will change to amber.
- If the pressure level reaches the set high-pressure alarm threshold, the cab pressure level display will change color to red and the alarm will sound.
- The alarm condition will remain until the pressure returns to within the alarm thresholds or the monitor is reset (cycled off/on).
- The audible alarm can be muted. (See *Muting the Alarm*, page 14)

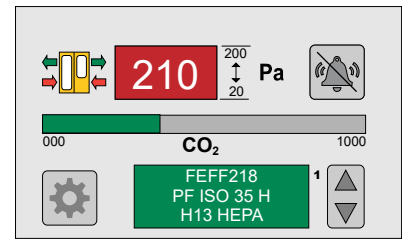

### Alarm Color Codes

- **Green:** Inside of set permissible limits
- **Amber:** 10% above set low-pressure threshold or 10% below set high-pressure threshold
- **Red:** At or outside of the set low or high threshold

## CO<sub>2</sub> Warning and Alarm

- When the CO<sub>2</sub> level increases to 10% (of the range) below the set primary CO<sub>2</sub> alarm threshold, the CO<sub>2</sub> PPM level display color will change to amber.
- If the CO<sub>2</sub> PPM level reaches the set primary CO<sub>2</sub> PPM alarm threshold, the CO<sub>2</sub> PPM level display will change color to red and the alarm will sound.
- The alarm condition will remain until the CO<sub>2</sub> PPM level returns to within the primary alarm threshold or the monitor is reset (cycled off/on).
- The audible alarm generated by the primary set CO<sub>2</sub> PPM alarm threshold can be muted. (See *Muting the Alarm*, page 14)
- If the CO<sub>2</sub> PPM level reaches 2500 PPM, the secondary, non-adjustable CO<sub>2</sub> PPM alarm will sound, and it is only able to be muted for a set interval between 0-10 minutes until cab conditions return to within thresholds.

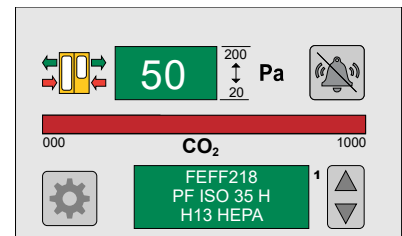

### Alarm Color Codes

- **Green:** Below limit, up to 89% of set primary CO<sub>2</sub> threshold
- **Amber:** 90% to 99% of set primary CO<sub>2</sub> threshold
- **Red:** At or above primary CO<sub>2</sub> threshold

## Filter Life Warning and Alarm

- When the filter life hours decrease to 20% of the maximum filter life hours remaining, the filter identification display will change color to amber.
- If the filter life hours reach the maximum filter life hours, the filter identification display will change color to red and the alarm will sound.
- The alarm condition will remain until the expired filter(s) is replaced. (See *Replacing the Filter*, page 14)
- The audible alarm can be muted. (See *Muting the Alarm*, page 14)

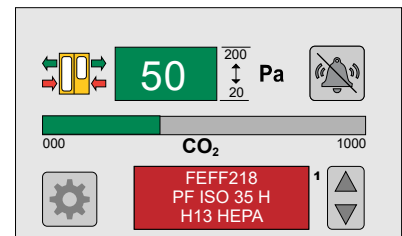

### Alarm Color Codes

- **Green:** 21% to 100% of filter life remaining
- **Amber:** 20% or less of filter life remaining
- **Red:** No filter life remaining

## Muting the Alarm

- During active alarm conditions, the **Alarm button** will change to the **Silence Alarm button**.
- Press the **Silence Alarm button** to silence the audible alarm.
- The **Silence Alarm button** will remain until the alarm condition is resolved.



**Alarm Button**



**Silence Alarm Button**

## Replacing the Filter

- Replace filter(s) per standard operating procedure.
- Go to **Filter Selection Screen**, page 7, to remove and reassign the filter. This will restore filter life to 100% and set filter-life hours to default maximum value.
  1. Set left **Selected Filter Display** to REMOVED.
  2. Press filter housing number of filter that was replaced until REMOVED and filter housing number show on the **Installed Filter Display**.
  3. Press **Confirm button**, then press **Filter Selection Menu button** on Main Menu to reassign new filter.
  4. Filter housing is now available to reassign filter type following the steps on page 7.
- If you wish to change the filter-life hours after reassigning the filter, see the **Filter Life Setting** screen, page 9.

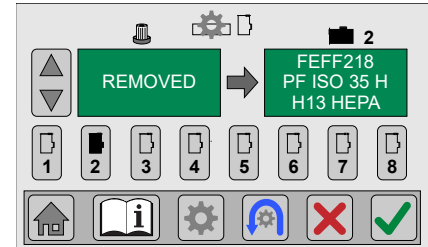

**Filter removed**

## Bluetooth Setting

If the background of the Pressure Display on the main display is not showing Red, Amber, or Green, the APS has not connected.

### Reconnecting Instructions:

1. To restart, cycle power to the RESPAS Advisor+.
2. If the APS does not connect after 30 sec, press the **Scan** button to scan for available devices.
3. An APS should appear in the Scanned Devices display. Press the **Connect** button.
4. Press the **Up/Down Connected Devices buttons**. The APS should now show in the **Connected Devices** display.

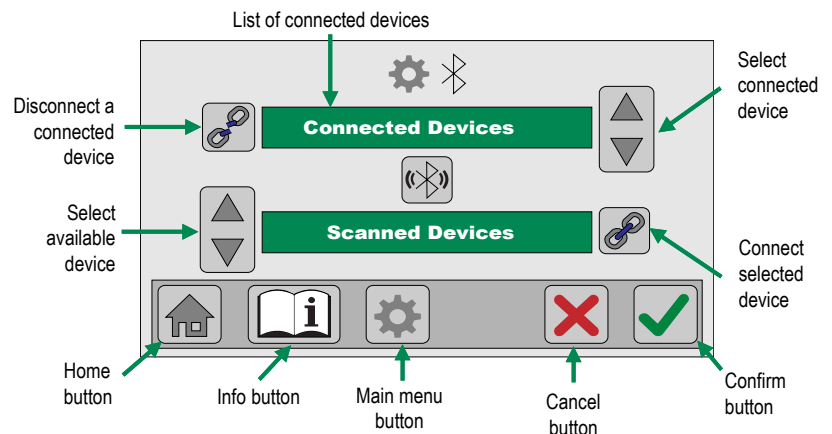

**NOTE:** If the RESPAS Advisor+ still cannot be connected to an Ambient Pressure Sensor (APS), contact Sy-Klone at [support@sy-klone.com](mailto:support@sy-klone.com).

## Recalibrating the Monitor

If you are seeing erratic readings, or if you open the cab door and the pressure does not drop to zero, it is time to recalibrate the monitor.

To recalibrate the RESPA Advisor+:

1. Press the **Main Menu button** on the main display.
2. The **PIN Code Screen** will be displayed.
  - a. Enter the six-digit recalibration PIN code. (**777779**)
 

**TIP:** If you enter number incorrectly, press the **Reset button** to clear entry.
  - b. Press the **Confirm button** to restart and recalibrate the monitor.

## Data Logging Interval Setting

To access the **Data Logging screen**, press the **Data logging button** on the Main Menu.



1. Use the **Up/Down Data Sampling Interval buttons** to adjust the interval at which samples are logged. **NOTE:** Selecting one second intervals will give you a log of approximately one hour, ten second intervals will give you a log of approximately 10 hours, etc.
2. Press the **Reset button** to return the data sampling interval to 10 seconds.
3. Press the **Confirm button** to confirm any changes and return to the Main Menu screen.
 

**NOTE:** If you press the **Confirm button**, all previous logging will be erased.

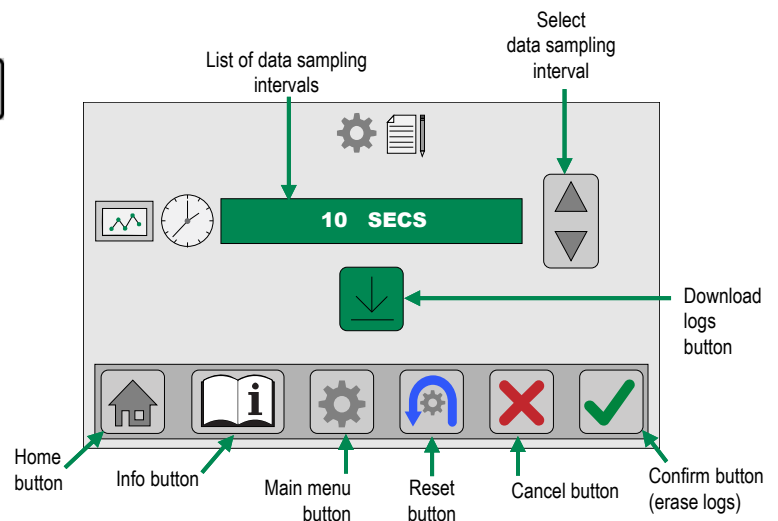

## Data Logging Download

Please visit [www.sy-klone.com/RAinfo](http://www.sy-klone.com/RAinfo) or scan the QR code provided in the information screen for instructions on how to access to the Sy-Klone phone application.

1. On the monitor, press the **Download Logs button** to allow the Sy-Klone phone application to connect to the RESPA Advisor+.
2. Follow the prompts within the Sy-Klone phone application to download the logs to your mobile device.
3. Press the **Home button** to return to the main display.
4. Press the **Main Menu button** to return to the Main Menu screen.

**NOTE:** Pressing the **Confirm button** will erase all previous logs.

