

## Service Bulletin: Ejector Port Location

### WHEN INSTALLING THE FILTER:

The filter ejection port must be oriented during the filter's installation. The ejection port can be oriented in four different positions, every 90°, in the filter housing. The filter housing has four alignment grooves for orienting the filter ejection port.

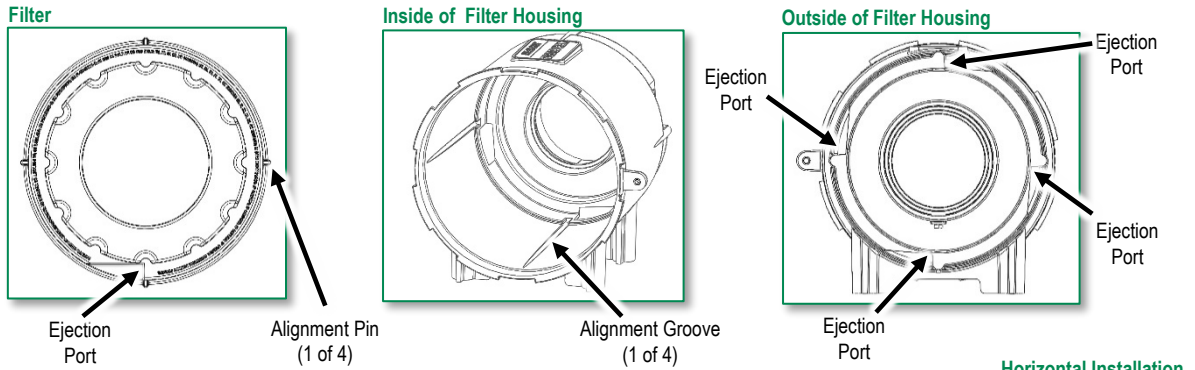

- **IMPORTANT:** The Vortex MAX ejects debris at a high rate. Be sure the ejection port is pointed away from any surface in close proximity and away from the operator's field of vision.
- Locate the ejection port at the **lowest point possible** when mounting horizontally.
- Do not locate the ejection port in a fashion where water can fall/run into the filter housing.
- Take extra care to prevent high-pressure water or air from entering the Vortex MAX ejection port during cleaning.

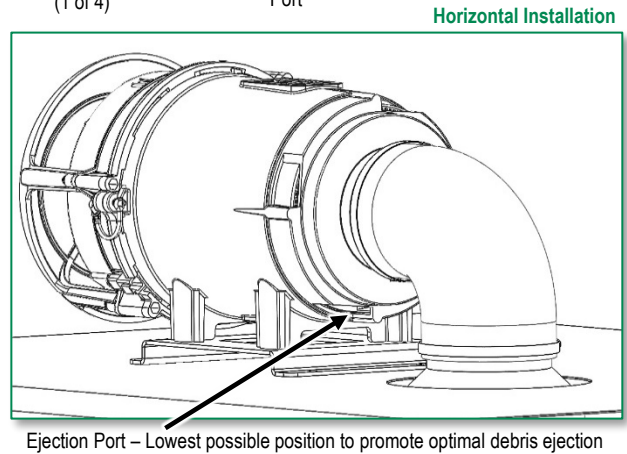

### WHEN REPLACING THE FILTER:

- Note the filter ejection port location when removing filter. Install the replacement filter with the ejection port in the same location. If the ejection port location is not at the lowest point of gravity, to promote debris ejection, see above instructions.
- Ensure the Vortex MAX wiring harness is reconnected after installation of the motor housing.
- After installing the new filter, inspect the Vortex MAX system for proper operation.
  - System is running.
  - The fan should be moving and pushing air through the system. If power to the fan is not reconnected, the fan will not operate and precleaning efficiency will be impacted.
  - Air flow out of the Vortex MAX system ejection port is strong.

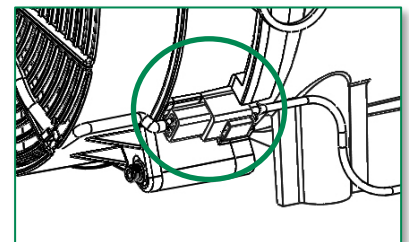
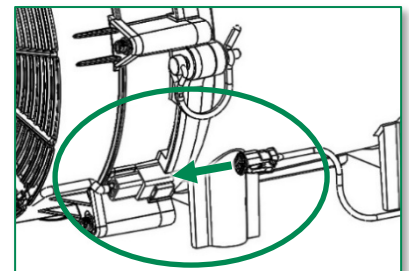

## Service Bulletin: Vacuator Valve Replacement

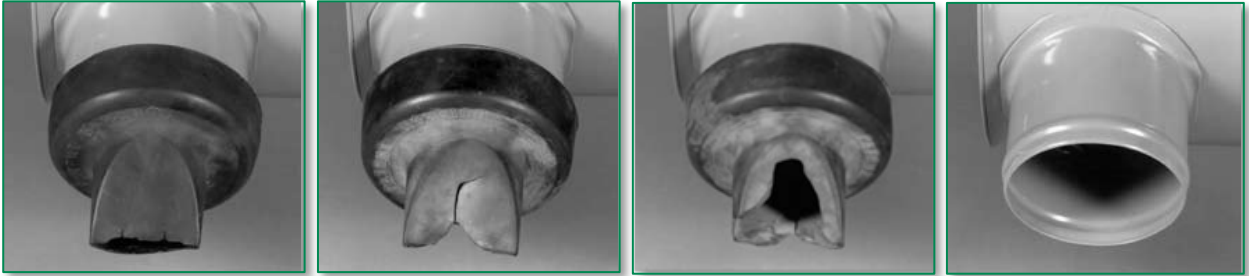

Vacuator valves are included on most filter housings, often referred to as dump valves which are on the vacuator port ( DVP). They can become damaged, lost, or painted allowing debris to bypass the precleaner and enter the filter housing directly. This will greatly reduce the performance benefits of the Sy-Klone precleaner.

### REPLACE THE VACUATOR VALVE ON ALL SY-KLONE PRECLEANER INSTALLATIONS:

#### Installation Instructions:

1. Remove the vacuator valve from the end of the vacuator tube (located on the air filter housing).
2. Clean the inside of vacuator tube.
3. Install option 1 or option 2.

#### Option 1: DVP Cap

1. Install a vacuator cap onto the vacuator tube.
2. Secure with a zip tie.

#### Option 2: DVP Plug

1. Insert a vacuator plug into the vacuator tube.
2. Tighten the nut on the vacuator plug while holding in place to secure.

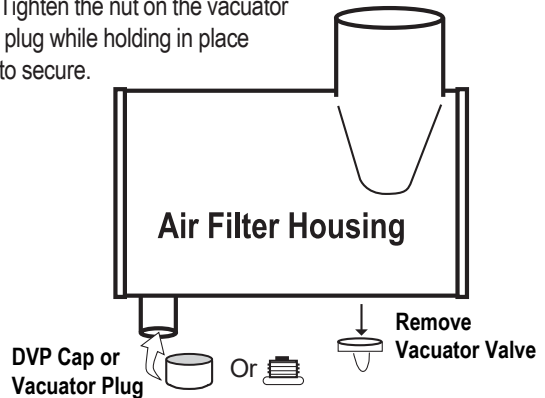
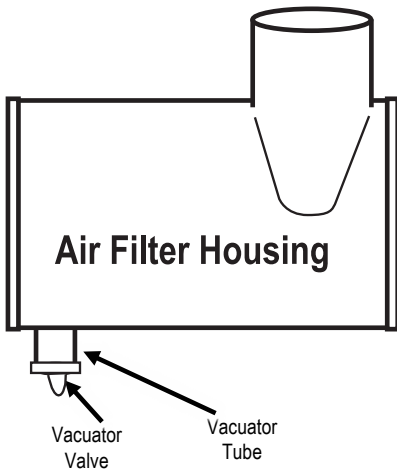

**Warning! Do not attempt to install, remove, or inspect unit while engine is running. Do not insert objects into open areas while in operation.**



**KT0009:** Includes 1.375, 1.5, 2, and 3-inch DVP caps and zip tie.



**DVP-3930** for a 3-inch hole  
**DVP-3920** for a 2-inch hole  
**DVP-3915** for a 1.5-inch hole  
**DVP-39125** for a 1.25-inch hole